

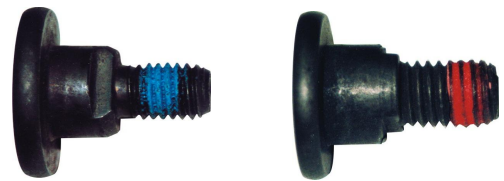





TORNILLOS CUCHILLA SEGADORA

KNIFE BOLTS: MOWER

		Medida <i>Measure</i>	Ud./Caja <i>Pcs./Box</i>		
VICON ADAPTABLE	12.9	10 x 31	50		
	10.9	12 x 36	50		
KUHNS ADAPTABLE 12.9		10 x 30	50		*
		12 x 33	50		
* ADAPTABLE FORT & PERGORARO					
PÖTTINGER ADAPT. 10.9		12 x 29	50		
		12 x 37	50		
TAARUP ADAPTABLE 10.9		12 x 35	50		
KRONE ADAPTABLE 10.9		12 x 30	50		
BCS ADAPTABLE 10.9		10 x 14	50		
DEUTZ-FAHR ADAPT. 10.9		10 x 12,5	50		

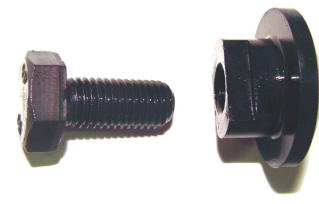
Con Tuerca Blocante / *Lock Nut included*



TORNILLO GASPARDO, SEGADORA

GASPARDO BOLT, MOWER



Diamet.	Long.	Pcs./Box
10	60	50

Cl. / Gr.
8.8

Con Tuerca / *With Nut*

TORNILLO BCS, SEGADORA

BCS BOLT, MOWER



Diamet.	Long.	Pcs./Box
M-8 / 1,00	12	200
	14	200
M-10 / 1,25	30	200

TORNILLOS REGISTRO / *FITTING BOLTS*

	Medida / <i>Measure</i>	Pcs./Box
Arado con Prisionero / <i>Countersunk one Nib</i>	12x 45	50
Allen Cab. Plana / <i>Countersunk Hex. Inbus</i>	12x 45	50
Cab. Redonda c/c / <i>Mush. Head Squa. Neck</i>	12x 45	50

Con Tuerca / *With Nut*

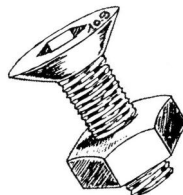
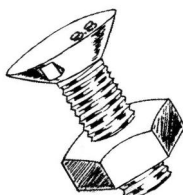

ESPARRAGOS REGISTRO / *SET SCREWS*

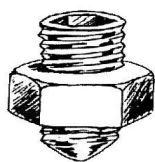

	Medida / <i>Measure</i>	Pcs./Box
Espárragos registro <i>Set screws</i>	10x 25	100
	12x 25	100

Con Tuerca / *With Nut*

